

# Data Sheet



Article number: 12513600050100  
Description: KLEE-coil 513 600 050.100  
M5 Hardened, zinc-pl.

## Measures

---

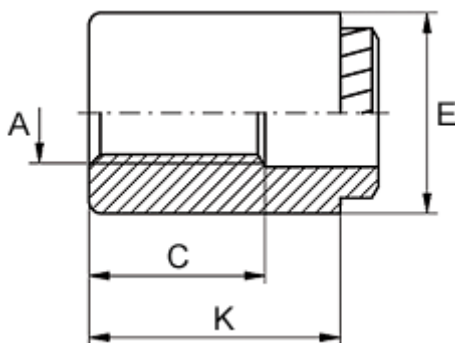

Female thread A	= M5
Height K	= 13
Hole diameter +0.1	= 6.8
Min distance to edge	= 4.1
Min material thickness	= 1.5
Outer diameter E	= 9
Thread length	= 9